MXLX20-D6C-CT1

Features

- ◆ Single fiber bi-directional data links with asymmetric 9.953Gbps downstream and 2.488Gbps upstream
- ◆ 1577nm continuous-mode EML laser transmitter and 1270nm burst-mode APD-TIA receiver
- ◆ 0 to 70°C operating case temperature
- ◆ +3.3V power supply
- ◆ XFP package with SC/UPC Receptacle connector
- ◆ 2-wire interface for integrated Digital Diagnostic Monitoring
- ◆ Digital Receiving Signal Strength Indication (RSSI)
- ◆ Low EMI and excellent ESD protection
- ◆ Class1 laser safety standard IEC-60825 compliant
- ◆ RoHS compliance

Application

- ◆ XGPON1 OLT (ODN:N2a class)

Standard

- ◆ Complies with INF-8077i
- ◆ Complies with ITU-T G.987.2
- ◆ Complies with FCC 47 CFR Part 15, Class B
- ◆ Complies with FDA 21 CFR 1040.10 and 1040.11 except for deviations pursuant to Laser Notice No. 50, dated June 24, 2007

Description

The MXLX20-D6C-CT1 is an XG-PON1 OLT optical transceiver designed for low cost point-to-multipoint (P2MP) Fiber to Home (FTTH), Business or Curb (FTTx) applications. It employs a 1577nm EML CW mode downstream transmitter operating at 9.95328Gb/s and a 1270nm APD/TIA burst mode upstream receiver operating at 2.48832Gb/s. It is housed in a hot pluggable XFP package and is designed to operate over the commercial temperature range from 0 to 70°C.

Specification

Absolute Maximum Ratings				
Parameter	Symbol	Min	Max	Unit
Storage temperature	T _s	-40	+85	°C
Operating case temperature	T _c	0	+70	°C
Storage Relative Humidity	RH _s	5	95	%
Operating Relative Humidity	RH _o	5	85	%
Power Supply Voltage	V _{cc}	0	+3.6	V

Recommended Operating Conditions					
Parameter	Symbol	Min	Typical	Max	Unit
Operating Case Temperature	T _c	0	+25	+70	°C
Power Supply Voltage	V _{CC3}	3.135	3.3	3.465	V
Supply Current	I _{CC3}	-	-	900	mA
Power Consumption	P _w	-	-	3	W
Data Rate		-	TX 9.953 RX 2.488	-	Gbps

Electrical Characteristics						
Parameter	Symbol	Min	Typical	Max	Unit	Notes
Transmitter Differential Data Input Swing	V _{INPP}	600	-	1600	mV	
Transmitter Differential Input Impedance	Z _{IN}	80	100	120	Ω	
Receiver Differential Data Output Swing	V _{OUTPP}	400	800	1600	mV	
Receiver Differential Output Impedance	Z _{OUT}	80	100	120	Ω	
TX Disable	V _{TDH}	2.0	-	V _{CC}	V	LVTTTL input
	V _{TDL}	0	-	0.8		
TX Fault	V _{TFH}	2.0	-	V _{CC}	V	LVTTTL output
	V _{TFL}	0	-	0.8		
RX Reset	V _{RSTH}	2.0	-	V _{CC}	V	LVTTTL input
	V _{RSTL}	0	-	0.8		
Signal Detect (RX SD)	V _{SDH}	2.0	-	V _{CC}	V	LVTTTL output
	V _{SDL}	0	-	0.8		

Optical transmitter Characteristics						
Parameter	Symbol	Min	Typical	Max	Unit	Notes
Operating Wavelength Range	λ_c	1575	1577	1580	nm	
Launched Power	P_{OUT}	+4	-	+8	dBm	
Spectral Width(-20dB)	$\Delta\lambda$	-	-	1	nm	
Side Mode Suppression Mode	SMSR	30	-	-	dB	
Extinction Ratio	ER	8.2	-	-	dB	PRBS 2 ³¹ -1 @9.953Gbps
Optical Output Power after TX Disable	P_{OFF}	-	-	-39	dBm	
Transmitter tolerance to reflected optical power		-15	-	-	dB	
Output Eye Diagram	Compliant with ITU-T G.987.2					
Optical receiver Characteristics						
Parameter	Symbol	Min	Typical	Max	Unit	Notes
Operating Wavelength Range	λ_c	1260	1270	1280	nm	
Receiver Sensitivity	P_{SEN}	-	-	-29.5	dBm	PRBS 2 ²³ -1 @2.488Gbps BER<1x10 ⁻⁴ ER=8.2dB
Saturation Optical Power	P_{SAT}	-9	-	-	dBm	
Immunity from Continuous Identical Digits	CID	72	-	-	Bit	
Receiver Reflectance		-	-	-20	dB	
Tolerance to the reflected optical power		-	-	10	dB	

Receiver Timing Characteristics						
Parameter	Symbol	Min.	Typ.	Max.	Unit	Notes
Guard Time	T_g	4	-	-	Byte	
Reset Pulse Width	T_r	25.6	-	-	ns	
Data Recovery Time	T_{settle}	-	-	25.6	ns	
SD Assert Time	T_a	-	-	50	ns	
SD De-assert Time	T_d	-	-	12.8	ns	

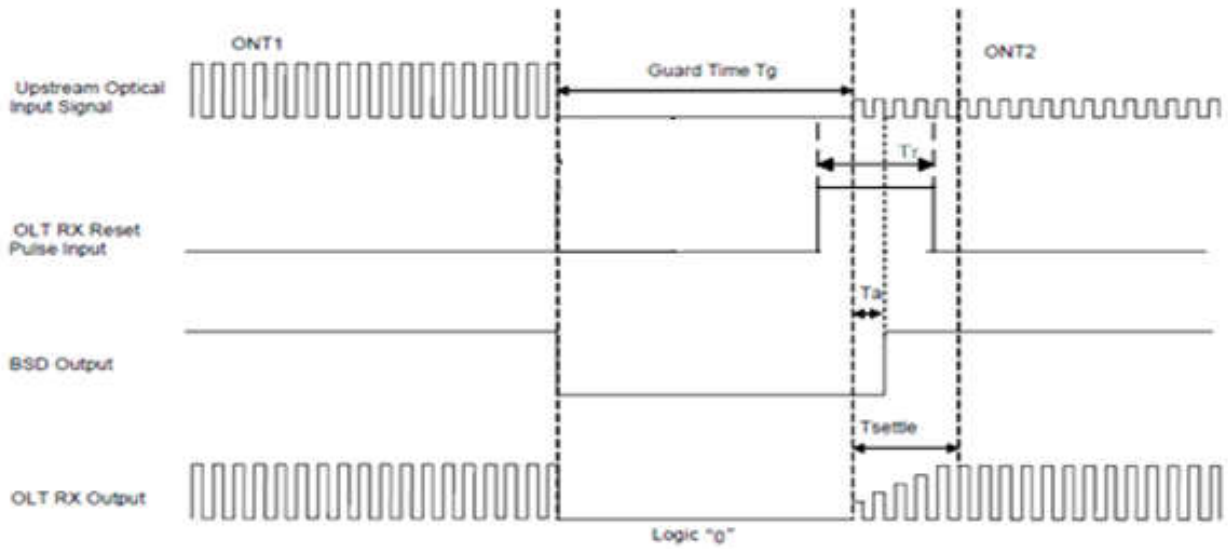

Figure 1 Timing Parameter Definitions in Burst Mode Sequence a

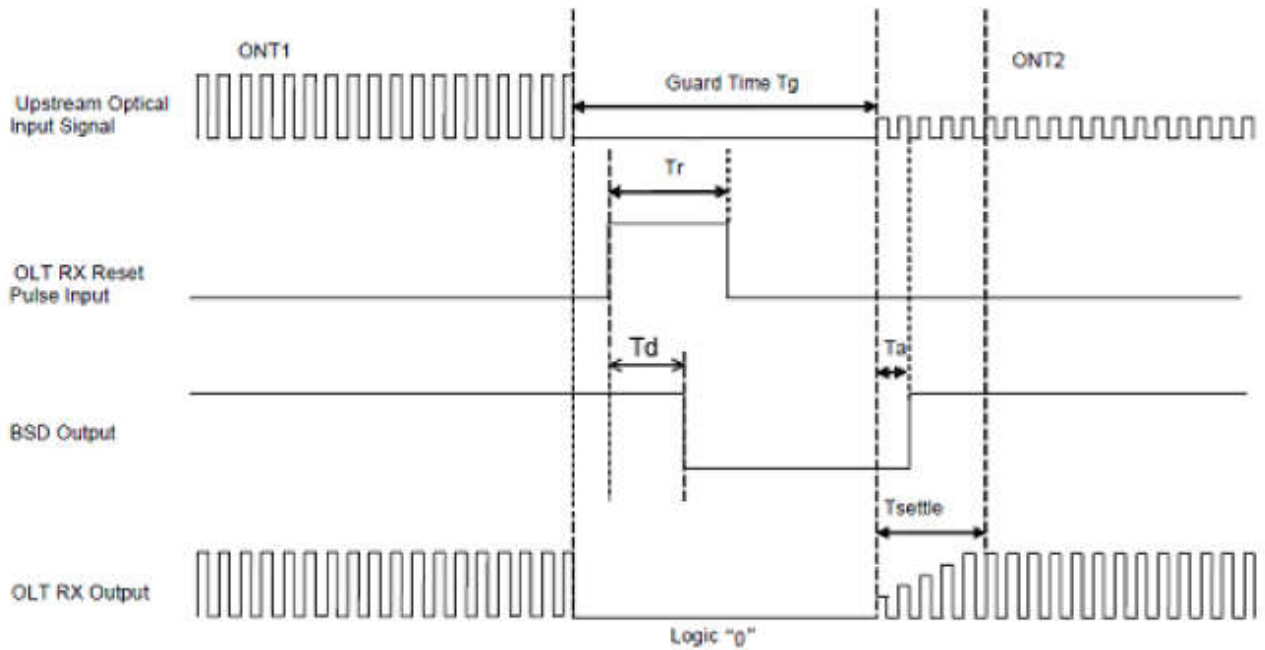

Figure 2 Timing Parameter Definitions in Burst Mode Sequence b

RSSI Characteristics						
Parameter	Symbol	Min.	Typ.	Max.	Unit	Notes
RSSI Trigger-Low		0	-	0.8	V	
RSSI Trigger-High		2.0	-	V _{CC}	V	
RSSI Trigger Delay	T _D	25	-	-	ns	
Optical Signal During Time	T _{ONT}	300	-	-	ns	
RSSI Trigger width	T _W	300	-	T _{ONT} - T _D	ns	
I2C Access Prohibited Time	T _p	500	-	-	μs	

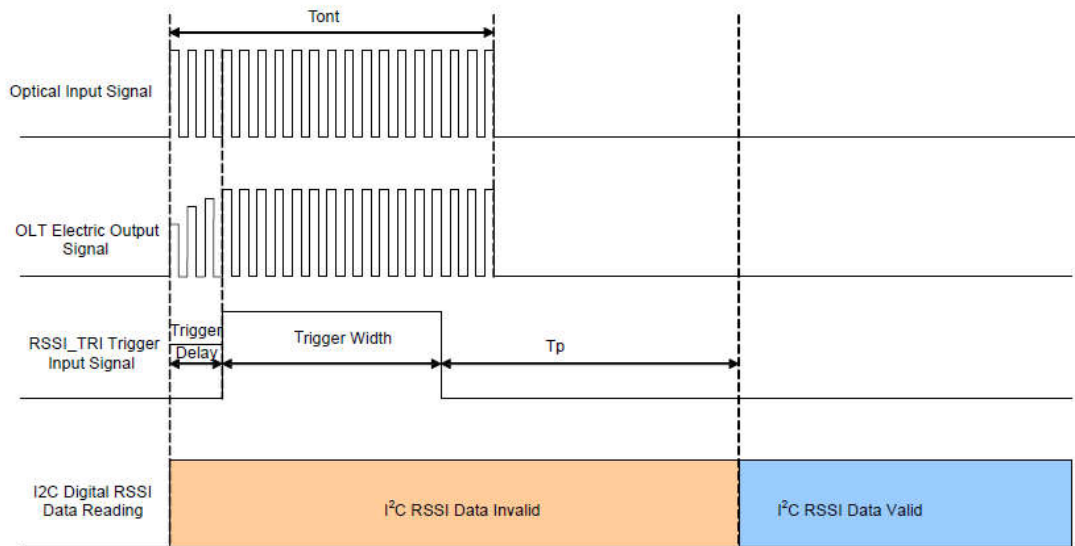

Figure 3 Timing Parameter Definitions in RSSI Trigger

Digital Diagnostic Monitoring Information

Parameter	Accuracy	Calibration	Note
Temperature	±3°C	Internal	
Voltage	±3%	Internal	
Bias Current	±10%	Internal	Quantization Unit 4uA
TX Power	±2dB	Internal	Quantization Unit 0.2μW
RX Power	±3dB	External	-30 to -9dBm(Quantization Unit 0.1μW)

Pin Definition

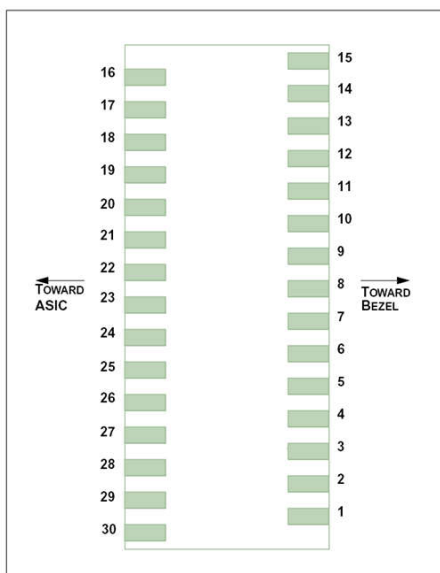

Figure 4 Pin out Drawing

Pin No	Name	Default Description	Note
1	GND	Module Ground	
2	TX_FAULT	Transmitter fault Indication	LVTTL Output
3	NC	Not connect	
4	NC	Not connect	
5	TX_DIS	Transmitter Disable	LVTTL Input; Low: transmitter on
6	VCC5	Transmitter 5V Power Supply	
7	GND	Module Ground	
8	VCC3_TX	Transmitter 3.3V Power Supply	
9	VCC3_RX	Receiver 3.3V Power Supply	
10	SCL	2-Wire Serial Interface clock line	LVTTL
11	SDA	2-Wire Serial Interface data line	LVTTL
12	MOD_ABS	Module Absent indicate pin; Grounded in the Module	LVTTL Output
13	RX_RESET	Burst Module Reset Signal, high active	LVTTL Input
14	RX_SD	High: signal detected; Low: loss of signal	LVTTL Output
15	GND	Module Ground	
16	GND	Module Ground	
17	RD-	Inverted Received Data Out	CML Output, AC coupled
18	RD+	Non-inverted Received Data Out	CML Output, AC coupled
19	GND	Module Ground	

20	NC	Not connect	
21	RSSI_TRIG	RSSI Trigger for Transceiver	High: enable RSSI A/D conversion, LVTTTL Input
22	NC	Not connect	
23	GND	Module Ground	
24	NC	Not connect	
25	NC	Not connect	
26	GND	Module Ground	
27	GND	Module Ground	
28	TD-	Inverted Transmit Data in	CML Input, AC coupled
29	TD+	Non-Inverted Transmit Data in	CML Input, AC coupled
30	GND	Module Ground	

Typical application Circuit

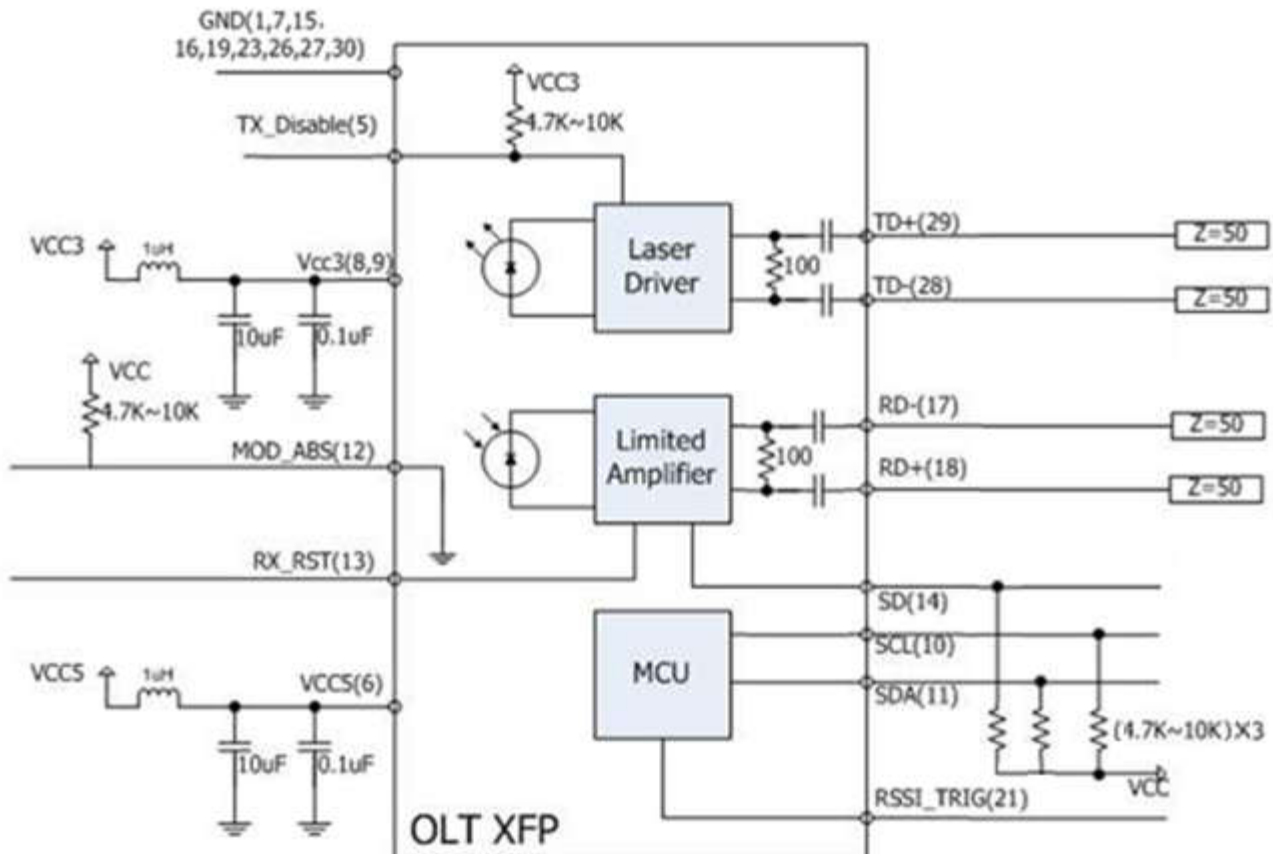

Figure 5 Typical Interface Circuit

EEPROM Serial ID Memory Contents

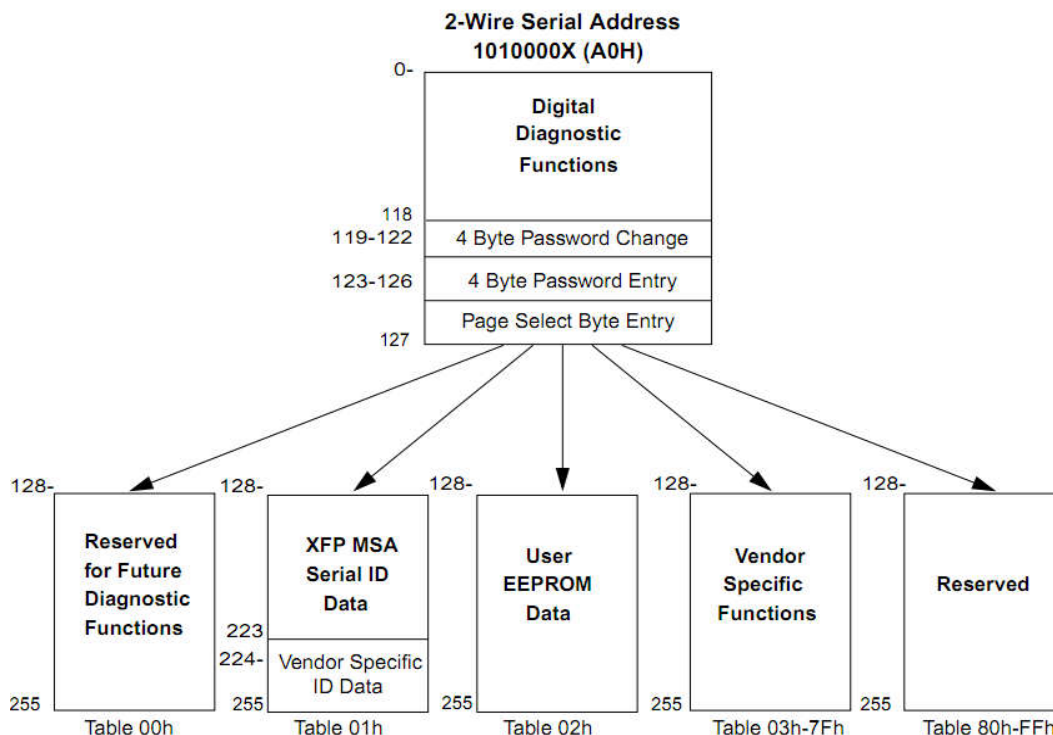

Figure 6 EEPROM Memory Map Specific Data Field Descriptions

Lower Memory Map (2-Wire Address A0h): Alarm and Warning

Thresholds

Address	Field Size(Byte)	Name of field	Description
00	1	Identifier	XFP transceiver, 06h
01	1	Signal Conditioner Control	Data Rate Control, 00h
02-03	2	Temp High Alarm	MSB at low address, 80°C
04-05	2	Temp Low Alarm	MSB at low address, -10°C
06-07	2	Temp High Warning	MSB at low address, 70°C
08-09	2	Temp Low Warning	MSB at low address, 0°C
10-11	2	3.3V Voltage High Alarm	MSB at low address, 3.6V
12-13	2	3.3V Voltage Low Alarm	MSB at low address, 3.0V
14-15	2	3.3V Voltage High Warning	MSB at low address, 3.5V
16-17	2	3.3V Voltage Low Warning	MSB at low address, 3.1V
18-19	2	Bias High Alarm	MSB at low address, 125mA
20-21	2	Bias Low Alarm	MSB at low address, 5mA

22-23	2	Bias High Warning	MSB at low address, 110mA
24-25	2	Bias Low Warning	MSB at low address, 10mA
26-27	2	TX Power High Alarm	MSB at low address, +9dBm
28-29	2	TX Power Low Alarm	MSB at low address, +3dBm
30-31	2	TX Power High Warning	MSB at low address, +8dBm
32-33	2	TX Power Low Warning	MSB at low address, +4dBm
34-35	2	RX Power High Alarm	MSB at low address, -7dBm
36-37	2	RX Power Low Alarm	MSB at low address, -31.5dBm
38-39	2	RX Power High Warning	MSB at low address, -9dBm
40-41	2	RX Power Low Warning	MSB at low address, -29.5dBm
42-43	2	AUX 1 High Alarm	Not Support
44-45	2	AUX 1 Low Alarm	Not Support
46-47	2	AUX 1 High Warning	Not Support
48-49	2	AUX 1 Low Warning	Not Support
50-51	2	AUX 2 High Alarm	Not Support
52-53	2	AUX 2 Low Alarm	Not Support
54-55	2	AUX 2 High Warning	Not Support
56-57	2	AUX 2 Low Warning	Not Support
58-59	2	Optional VPS Control Registers	Not Support
60-69	9	Reserved	-
70-71	2	BER Reporting	Not Support
72-75	4	Wavelength Control Registers	Not Support
76-79	4	FEC control Registers	Not Support
80-87	8	Latched Interrupt Flag Fields	See Table 1.1
88-95	8	Interrupt Masking Bits	See Table 1.2
96-109	14	A/D readout	See Table 1.3
110-111	2	General Control/Status Bits	See Table 1.4
112-117	6	Reserved	-
118	1	Serial Interface Read/Write Error Checking	Not Support
119-122	4	Password Change Entry Area	Location of Entry of New Optional Password
123-126	4	Password Entry Area	Location for Entry of Optional Password
127	1	Page Select Byte	Table Select

Table 1.1 Latched Interrupt Flag Fields

Data Address	Bit	Name of Field	Description
80	7	L-Temp High Alarm	Latched high Temperature alarm
80	6	L-Temp Low Alarm	Latched low Temperature alarm
80	5	L-3.3V Vcc High Alarm	Latched high Voltage alarm
80	4	L-3.3V Vcc Low Alarm	Latched low Voltage alarm
80	3	L-10G TX Bias High Alarm	Latched high 10G TX Bias alarm
80	2	L-10G TX Bias Low Alarm	Latched low 10G TX Bias alarm
80	1	L-10G TX Power High Alarm	Latched high 10G TX Power alarm
80	0	L-10G TX Power Low Alarm	Latched low 10G TX Power alarm
81	7	L-RX Power High Alarm	Latched high RX Power alarm
81	6	L-RX Power Low Alarm	Latched low RX Power alarm
81	5	L- AUX 1 High Alarm	Latched high AUX1 monitor alarm
81	4	L- AUX 1 Low Alarm	Latched low AUX1 monitor alarm
81	3	L- AUX 2 High Alarm	Latched high AUX2 monitor alarm
81	2	L- AUX 2 Low Alarm	Latched low AUX2 monitor alarm
81	1	Reserved	
81	0	Reserved	
82	7	L-Temp High Warning	Latched high Temperature warning
82	6	L-Temp Low Warning	Latched low Temperature warning
82	5	L-3.3V Vcc High Warning	Latched high Voltage warning
82	4	L-3.3V Vcc Low Warning	Latched low Voltage warning
82	3	L-10G TX Bias High Warning	Latched high 10G TX Bias warning
82	2	L-10G TX Bias Low Warning	Latched low 10G TX Bias warning
82	1	L-10G TX Power High Warning	Latched high 10G TX Power warning
82	0	L-10G TX Power Low Warning	Latched low 10G TX Power warning
83	7	L-RX Power High Warning	Latched high RX Power warning
83	6	L-RX Power Low Warning	Latched low RX Power warning
83	5	L- AUX 1 High Warning	Latched high AUX1 monitor warning
83	4	L- AUX 1 Low Warning	Latched low AUX1 monitor warning
83	3	L- AUX 2 High Warning	Latched high AUX2 monitor warning
83	2	L- AUX 2 Low Warning	Latched low AUX2 monitor warning
83	1	Reserved	
83	0	Reserved	
84	7	L-10G TX_NR	Not Support
84	6	L-10G TX_Fault	Not Support
84	5	L-10G TX CDR not Locked	Not Support

84	4	L-RX_NR	Not Support
84	3	L-RX_LOS	Not Support
84	2	L- RX CDR not Locked	Not Support
84	1	L- MOD_NR	Not Support
84	0	L- Reset Complete	Not Support
85	7	L- APD Supply Fault	Not Support
85	6	L- TEC Fault	Not Support
85	5	L- Wavelength Unlocked	Not Support
85	4-0	Reserved	
86	7	L-VCC5 High Alarm	Not Support
86	6	L-VCC5 Low Alarm	Not Support
86	5	L-VCC3 High Alarm	VCC3 High Alarm Flag
86	4	L-VCC3 Low Alarm	VCC3 Low Alarm Flag
86	3	L-VCC2 High Alarm	Not Support
86	2	L-VCC2 Low Alarm	Not Support
86	1	L-Vee5 High Alarm	Not Support
86	0	L-Vee5 Low Alarm	Not Support
87	7	L-VCC5 High Warning	Not Support
87	6	L-VCC5 Low Warning	Not Support
87	5	L-VCC3 High Warning	VCC3 High Warning Flag
87	4	L-VCC3 Low Warning	VCC3 Low Warning Flag
87	3	L-VCC2 High Warning	Not Support
87	2	L-VCC2 Low Warning	Not Support
87	1	L-Vee5 High Warning	Not Support
87	0	L-Vee5 Low Warning	Not Support

Table 1.2 Interrupt Masking Bits

Data Address	Bit	Name of Field	Description
88	7	M-Temp High Alarm	Masking high Temperature alarm
88	6	M-Temp Low Alarm	Masking low Temperature alarm
88	5	M-3.3V Vcc High Alarm	Masking high Voltage alarm
88	4	M-3.3V Vcc Low Alarm	Masking low Voltage alarm
88	3	M-10G TX Bias High Alarm	Masking high 10G TX Bias alarm
88	2	M-10G TX Bias Low Alarm	Masking low 10G TX Bias alarm
80	1	M-10G TX Power High Alarm	Masking high 10G TX Power alarm
88	0	M-10G TX Power Low Alarm	Masking low 10G TX Power alarm
89	7	M-RX Power High Alarm	Masking high RX Power alarm

89	6	M-RX Power Low Alarm	Masking low RX Power alarm
89	5	M- AUX 1 High Alarm	Masking bit for high AUX1 monitor alarm
89	4	M- AUX 1 Low Alarm	Masking bit for low AUX1 monitor alarm
89	3	M- AUX 2 High Alarm	Masking bit for high AUX2 monitor alarm
89	2	M- AUX 2 Low Alarm	Masking bit for low AUX2 monitor alarm
89	1	Reserved	
89	0	Reserved	
90	7	M-Temp High Warning	Masking high Temperature warning
90	6	M-Temp Low Warning	Masking low Temperature warning
90	5	M-3.3V Vcc High Warning	Masking high Voltage warning
90	4	M-3.3V Vcc Low Warning	Masking low Voltage warning
90	3	M-10G TX Bias High Warning	Masking high 10G TX Bias warning
90	2	M-10G TX Bias Low Warning	Masking low 10G TX Bias warning
90	1	M-10G TX Power High Warning	Masking high 10G TX Power warning
90	0	M-10G TX Power Low Warning	Masking low 10G TX Power warning
91	7	M-RX Power High Warning	Masking high RX Power warning
91	6	M-RX Power Low Warning	Masking low RX Power warning
91	5	M- AUX 1 High Warning	Masking bit for high AUX1 monitor warning
91	4	M- AUX 1 Low Warning	Masking bit for low AUX1 monitor warning
91	3	M- AUX 2 High Warning	Masking bit for high AUX2 monitor warning
91	2	M- AUX 2 Low Warning	Masking bit for low AUX2 monitor warning
91	1	Reserved	
91	0	Reserved	
92	7	M-10G TX_NR	Not Support
92	6	M-10G TX_Fault	Not Support
92	5	M-10G TX CDR not Locked	Not Support
92	4	M-RX_NR	Not Support
92	3	M-RX_LOS	Not Support
92	2	M- RX CDR not Locked	Not Support
92	1	M- MOD_NR	Not Support
92	0	M- Reset Complete	Not Support
93	7	M- APD Supply Fault	Not Support
93	6	M- TEC Fault	Not Support
93	5	M- Wavelength Unlocked	Not Support
93	4-0	Reserved	
94	7	M-VCC5 High Alarm	Not Support
94	6	M-VCC5 Low Alarm	Not Support
94	5	M-VCC3 High Alarm	Masking VCC3 High Alarm Flag
94	4	M-VCC3 Low Alarm	Masking VCC3 Low Alarm Flag

94	3	M-VCC2 High Alarm	Not Support
94	2	M-VCC2 Low Alarm	Not Support
94	1	M-Vee5 High Alarm	Not Support
94	0	M-Vee5 Low Alarm	Not Support
95	7	M-VCC5 High Warning	Not Support
95	6	M-VCC5 Low Warning	Not Support
95	5	M-VCC3 High Warning	Masking VCC3 High Warning Flag
95	4	M-VCC3 Low Warning	Masking VCC3 Low Warning Flag
95	3	M-VCC2 High Warning	Not Support
95	2	M-VCC2 Low Warning	Not Support
95	1	M-Vee5 High Warning	Not Support
95	0	M-Vee5 Low Warning	Not Support

Table 1.3 A/D readout

Data Address	Field Size (Byte)	Name of Field	Description	Range	Notes
96-97	2	Temperature	Internally measured module temperature, MSB at low address	-40 to 125°C	Case temperature
98-99	2	3.3V Supply Voltage	Internally measured supply voltage, MSB at low address	0V to 6.55V	
100-101	2	10G TX Bias	Internally measured 10G TX Bias Current, MSB at low address	0 to 262mA	Unit:4uA
102-103	2	10G TX Power	Measured 10G TX output power, MSB at low address	-37 to 11.2 dBm	Unit:0.2uW
104-105	2	RX Power	Measured RX input power, MSB at low address	-40 to 8.2 dBm	Unit:0.1uW
106-107	2	Reserved			
108-109	2	Reserved			

Table 1.4 General Control/Status Bits

Data Address	Bit	Name of Field	Description
110	7	TX Disable State	Digital state of the TX Disable Input Pin. Updated within 100msec of change on pin
110	6	Soft TX Disable	Optional read/write bit that allows software disable of laser. Writing '1' disables laser. Turn on/off time is 100msec max from acknowledgement of serial byte transmission. This bit is "OR" d with the hard TX_DISABLE pin value. Note, per SFP MSA TX_DISABLE pin is default enabled unless pulled low by hardware. If Soft 10G TX Disable is not implemented, the transceiver ignores the value of this bit. Default power up value is 0
110	5	MOD_NR State	Digital state of the MOD_NR Pin. Updated within 100msec of change on pin, not support
110	4	P_Down State	Digital state of the P_Down Pin. Updated within 100msec of change on pin, not support
110	3	Soft P_Down	Optional read/write bit that allows the module to be placed in the power down mode. This is identical to the P_Down hardware pin function except that it does not initiate a system reset, not support
110	2	Interrupt	Digital state of the Interrupt output pin, not support
110	1	RX_LOS	Indicates Optical Loss of Signal (per relevant optical link standard). Updated within 100msec of change on pin
110	0	Data_Not_Ready	Indicates transceiver has achieved power up and A/D data is ready. Bit remains high until data is ready to be read at which time the device sets the bit low, not support
111	7	TX_NR State	Identifies Not Ready condition as specific to the TX path, not support
111	6	TX_Fault State	Identifies Laser fault condition (Generated by laser safety system)
111	5	TX_CDR not Locked	Identifies Loss of Lock in TX path CDR, not support
111	4	RX_NR State	Identifies Not Ready condition as specific to the RX path, not support
111	3	RX_CDR not Locked	Identifies Loss of Lock in RX path CDR, not support
111	2-0	Reserved	

Serial ID: Data Fields – Page 01h

Address	#Bytes	Name	HEX	Description
Base ID Fields				
128	1	Identifier	06	XFP
129	1	Ext. Identifier	50	2.5W Max power dissipation; without CDR; TX Ref Clock Input not Required; No CLEI in table 02h
130	8	Connector	01	SC connector
131-138	8	Transceiver	00 00 00 00 00 00 00 00	Unallocated
139	1	Encoding	10	NRZ
140	1	BR-Min	63	9.95Gbps
141	1	BR-Max	63	9.95Gbps
142	1	Length(SMF)-km	14	20km
143	1	Length (E-50µm)	00	
144	1	Length (50 µm)	00	
145	1	Length (62.5 µm)	00	
146	1	Length (Copper)	00	
147	1	Device Tech	F6	Device technology (1577nm EML, Cooled transmitter, No wavelength control, APD detector)
148-163	16	Vendor name	4D 45 4E 54 45 43 48 4F 50 54 4F 20 20 20 20 20	“MENTECHOPTO”(ASCII character)
164	1	CDR Support	00	Not support
165-167	3	Vendor OUI	00 00 00	
168-183	16	Vendor PN	4D 58 4C 58 32 30 2D 44 36 43 2D 43 54 31 20 20	“MXLX20-D6C-CT1”
184-185	2	Vendor rev	41 30	“A0”
186-187	2	Wavelength	7B 34	Nominal laser wavelength: 1577nm
188-189	2	Wavelength Tolerance	01 F4	Guaranteed range of laser wavelength (+/- value) from Nominal wavelength: +3/-2nm
190	1	Max Case Temp	46	70°C

191	1	CC_BASE		Check sum of byte 128-190
Extended ID Fields				
192	4	Power Supply current requirements and max power dissipation	7D	Maximum Power Dissipation(2.5W)
193			00	
194			08	Maximum current
195			00	
196-211	16	Vendor SN		Serial number provided by vendor (ASCII)
212-219	8	Vendor's Date Code	"YYMMDDLL"	Vendor's manufacturing date code (ASCII)
220	1	Diagnostic Monitoring Type	08	Module Respond to FEC BER: No BER Support Received power measurement type : Average Power
221	1	Enhanced Options	40	Optional Soft Tx_Disable
222	1	Aux Monitoring	00	Not implemented
223	1	CC_EXT		
Vendor Specific ID Fields				
224-255	32	Vendor Specific		Vendor Specific EEPROM

Package Outline

Dimensions are in millimeters. (Unit: mm)

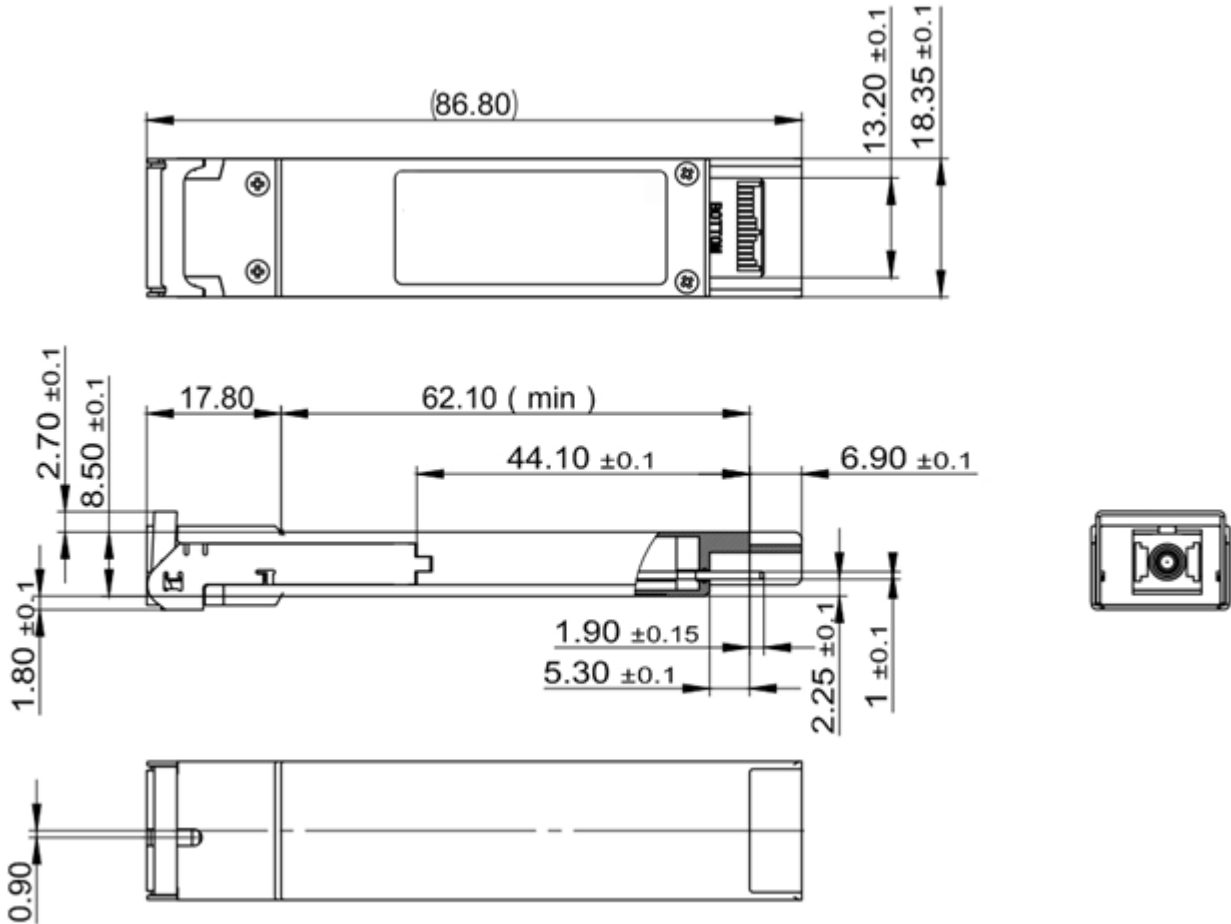

Figure 7 Package Outline

Ordering information

Part. No	Specifications								
	Package	Rate (Gbps)	Tx (nm)	Po (dBm)	Rx (nm)	Sen (dBm)	Temp (°C)	Reach (km)	DDM
MXLX20-D6C-CT1	XFP	TX 9.953 RX 2.488	1577	+4~+8	1270	<-29.5	0~70	20	Y